

H 4-7

4.5-ZIMMER- ATTIKA- WOHNUNG

Geschoss: 3. OG
Nettowoohnfläche: ca. 109 m²
Aussenfläche: ca. 23 m²
Keller: ca. 8 m²

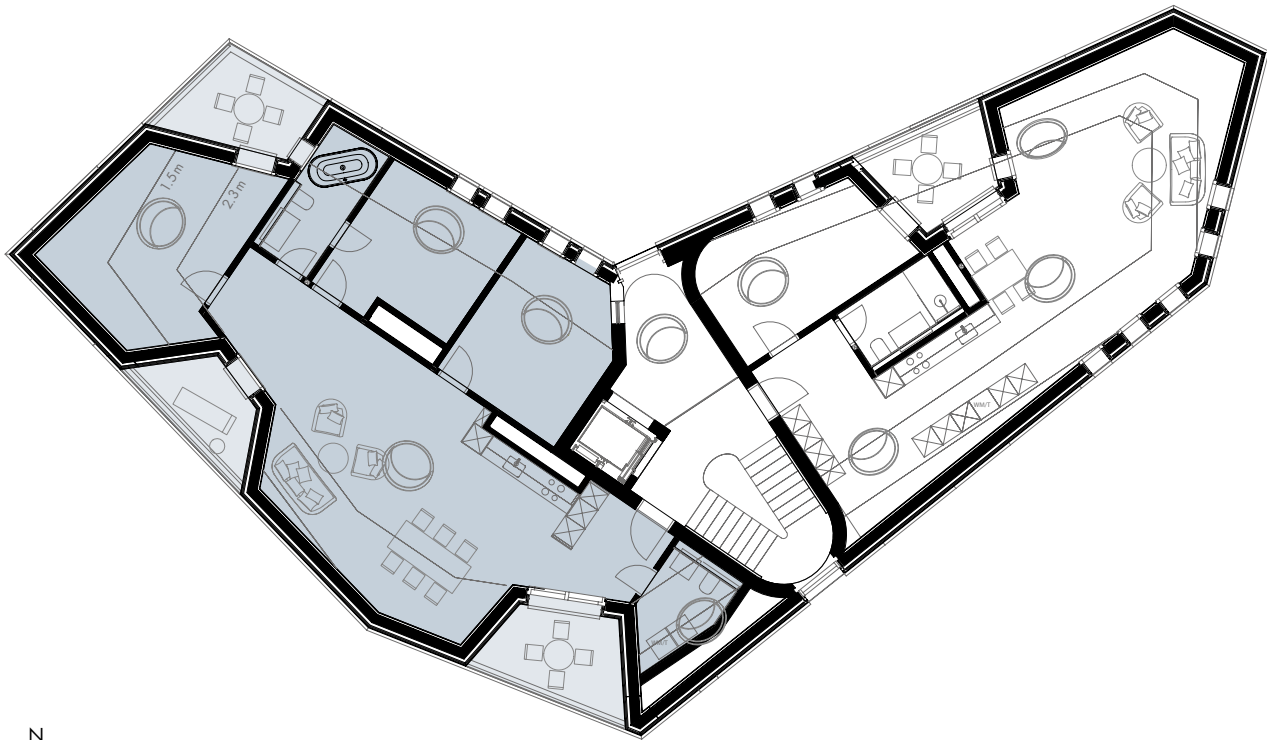
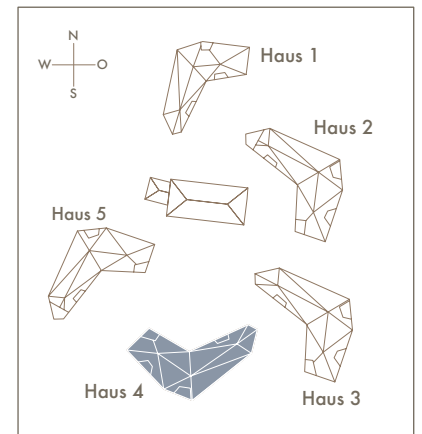
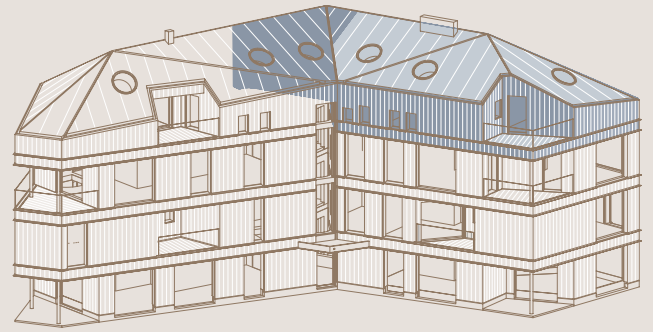

0m 1m 3m

Exklusiv Möblierung | Änderungen vorbehalten

LIEBWYLEN