

# H 2-3

## 4.5-ZIMMER- MAISONNETTE- GARTEN-WOHNUNG

Geschoss: EG/1. OG  
Nettowoohnfläche: ca. 130 m<sup>2</sup>  
Aussenfläche: ca. 14 m<sup>2</sup>  
Keller: ca. 8 m<sup>2</sup>

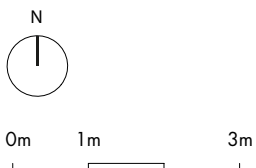
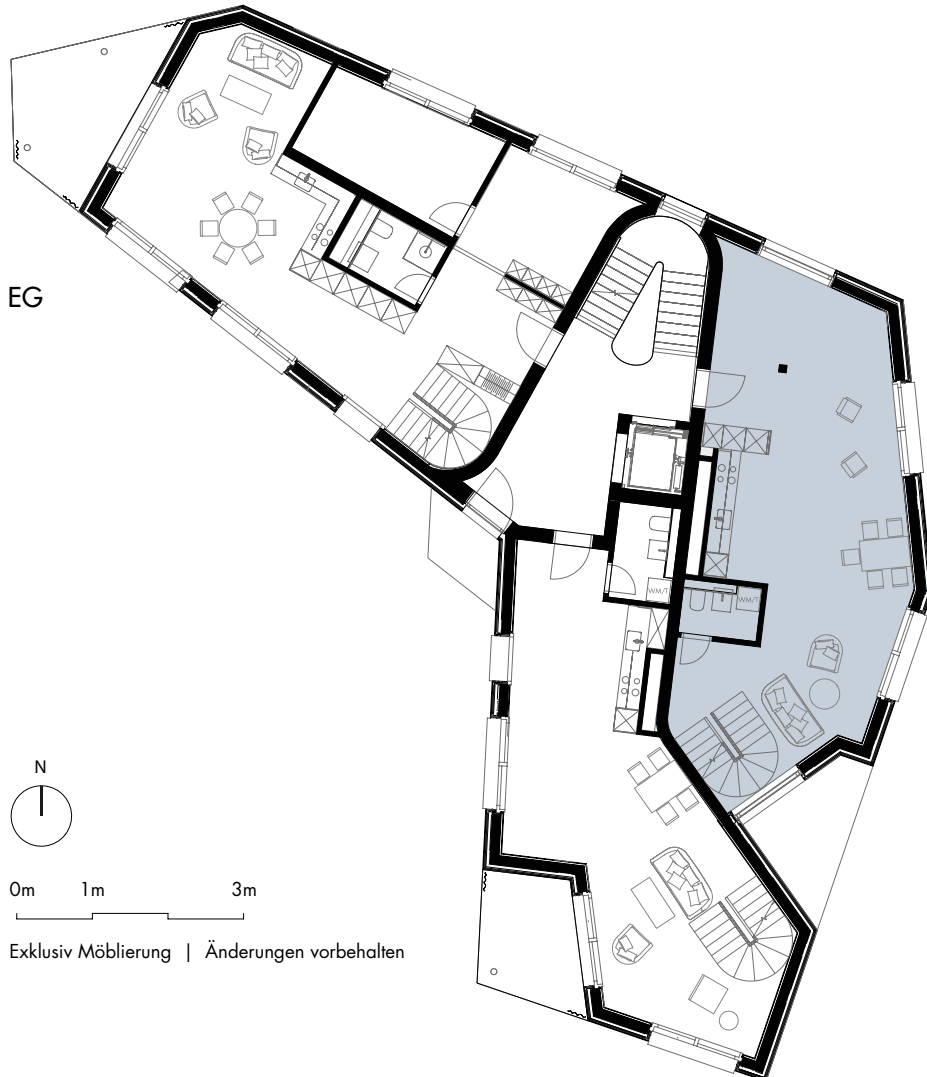
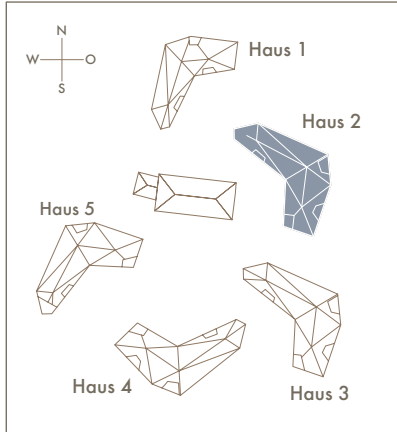
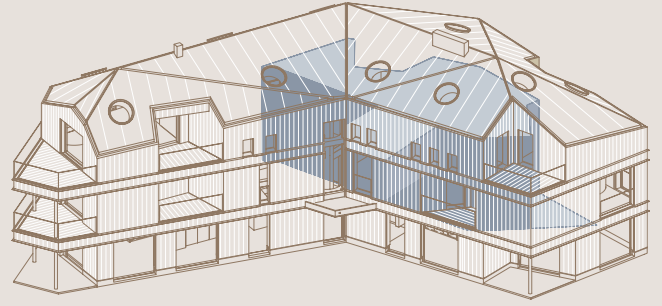

Exklusiv Möblierung | Änderungen vorbehalten

# LIEBWyLEN