

# H 1-2

## 2.5-ZIMMER- WOHNUNG

Geschoss: 1. OG  
Nettowoohnfläche: ca. 64 m<sup>2</sup>  
Aussenfläche: ca. 8 m<sup>2</sup>  
Keller: ca. 6 m<sup>2</sup>

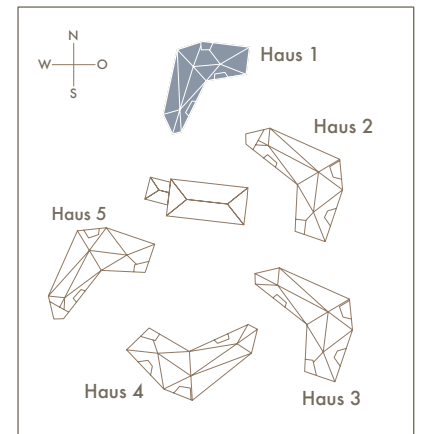
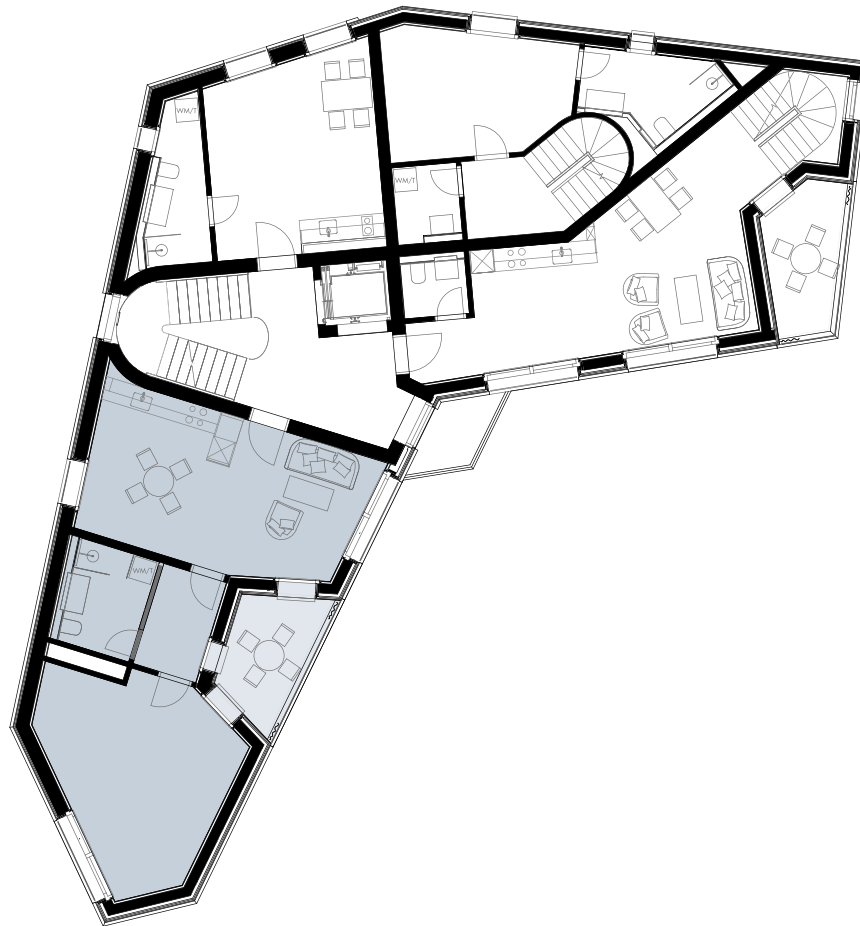
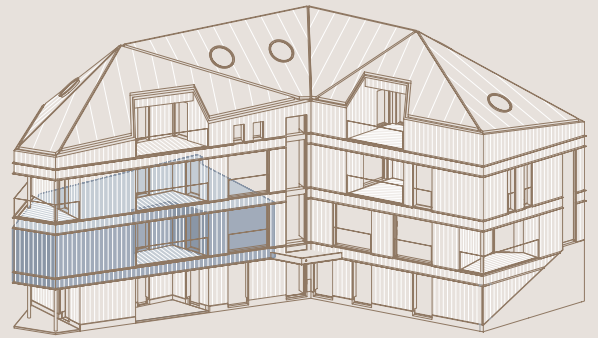

0m 1m 3m

Exklusiv Möblierung | Änderungen vorbehalten

# LIEBWyLEN